

Manual

N BOT

NDI Camera Motorized Head



Contents

Pre-Caution Before Operation / Warranty	3
N BOT, NDI Camera Motorized Head	
1. Introduction	6
2. Key Highlight	7
3. Technical Specification	8
4. Product Overview	9
4-1 Front	
4-2 Rear	
4-3 Components	
5. Operation	
5-1 LED Status	11
System Diagram	12
N BOT Controlling	13
CAMERA COMPATIBILITY	14
5-2 Video Over IP (NDI) Workflow	
6. SHARON Finder	
6-1 SHARON Finder Apps Download	15
6-2 SHARON Finder GUI	
Rename and Reconfigure IP Address	16
6-3 Reboot	
N BOT 6-5	
Reset	
Password	
7. N BOT Webserver	
7-1 Log In	17
7-2 System Mode	
Control Mode	18
Network Mode	19
7-3 Smart Phone Mode	
8. SONY Multiport Converter Modul	
8-1 The List of Camera Model	20
8-2 What to check if it doesn't work	

List of SONY Camera supported by SONY MULTIPOINT Interface shoe	21
8-3 List of camera tested in the ZFC-L zoom and focus control	
Appendix—A. N BOT VISCA IP COMMANDS Key List	23 - 25

Precautions before installation

Describes basic precautions that users should be aware of when installing and using the product in case of a situation that may cause bodily harm. Therefore, before installing or using the product, be sure to familiarize yourself with the information described here.

General precautions

During and after installation of the product, the area around the product must be kept clean and dust-free. Do not leave tools, cables, etc. in the aisle, as this may result in personal injury.

When installing the product, avoid wearing loose-fitting clothes, neckties, scarves, or sleeves that may get caught in the product.

Do not take any action that could cause damage to persons or equipment.

If you need to open the cover of the product to extend the product's performance or repair a malfunction, be sure to contact the place of purchase for professional help.

Power Precautions

When connecting power to the product, first check that the wiring is not overloaded.

When connecting the power to the product, do not wear jewelry such as rings, necklaces, or watches. If these accessories are connected to a power source or ground, there is a risk of burning the parts.

Always check the work area for potential hazards. Be sure to check for wet floors, ungrounded power extension cables, frayed internal power cords, and floors that do not have a safety grounding facility.

There must be an outlet near the appliance and the outlet must be easily accessible.

Install by service personnel and install the appliance so that it is connected to a socket-outlet with a protective earth wire.



Before proceeding with hardware installation, turn off the power of the system to be installed, and then touch a grounded surface such as the metal side of the power supply to discharge static electricity from the body.

The manufacturer assumes no liability for direct or indirect damage resulting from the use of improper parts by unauthorized service personnel.

If power is supplied during installation, it may cause damage to system components and body.

Power

The power cord and power outlet act as the main power disconnect device in case of an emergency such as a fire, so do not stack or block objects in front of the power outlet so that you can unplug the power cord from the power outlet at any time.



FCC Compliance Statement

This device complies with part 15 of the FCC rules. Operation is subject to the following two conditions:

(1) This device may not cause harmful interference, and (2) This device must accept any interference received, including interference that may cause undesired operation.



CE Marking is the symbol as shown on the left of this page. The letters "CE" are the abbreviation of French phrase "Conformité Européene" which literally means "European Conformity". The term initially used was "EC Mark" and it was officially replaced by "CE Marking" in the Directive 93/68/EEC in 1993. "CE Marking" is now used in all EU official documents.



Warranty

Standard 1 Year Warranty

- SalrayWorks product is guaranteed against any manufacturing defects for one year from the date of purchase.
- The original purchase invoice or other documentary evidence should be supplied at the time of any request for repair under warranty.
- The product warranty period begins on the purchase date. If the purchase date is unknown, the product warranty period begins on the thirtieth day after shipment from a SalrayWorks office.
- Damage caused by accident, misuse, unauthorized repairs, sand, grit or water is not covered under warranty.
- Viruses and malware infections on the computer systems are not covered under warranty.
- Any errors that are caused by unauthorized third-party software installations, which are not required by our computer systems, are not covered under warranty.
- All mail or transportation costs including insurance are at the expense of the owner.
- All other claims of any nature are not covered. All accessories including headphones, cables, batteries, metal parts, housing, cable reel and consumable parts are not covered under warranty.
- Warranty only valid in the country or region of purchase.
- Your statutory rights are not affected.

N BOT, NDI Camera Motorized Head

Robotic Pan Tilt Head

1. Introduction

*Bring the remote-control functionality to your Hand-held camcorder with the **N BOT Robotic Pan Tilt Head** from **Salrayworks**. More than just a motorized head, N BOT interfaces with PTZ-compatible control systems, allowing you the same kind of experience. From pan and tilt control to powering your camera and controlling its zoom lens via LANC or other protocols, this head is a compact PTZ solution for cameras weighing up to 3.2Kg. The head easily mounts to most tripod legs and with an optional bracket, it can be mounted on a wall or ceiling. It can send your camera's video output to external video displays, switchers, and controllers while also receiving control information for pan and tilt operations via VISCA IP or NDI . The head is equipped with LED indicators, a tally light, and a remote port that allows you to adjust the zoom and focus of select camera lenses.*

- o Multiple signal interfaces such as, HDMI, NDI, tally, and LANC
- o Sturdy aluminum construction
- o Camera pan, tilt, and zoom control
- o VISCA IP and NDI remote control
- o Compatible with NDI Studio Monitor, Salrayworks proStick Controller.
- o Built-in tally light
- o Ideal for live events
- o Control a variety of Sony, Panasonic, Canon, and JVC cameras
- o D-Tap power output to power camera and accessories
- o Plate with ¼ thread for camera mounting

2. Key Highlight

Salrayworks introduces N BOT, the world's first NDI® motorized camera head.

- Fitted with up to a 3.2 kg camera it moves up to 340 PAN degrees and TILT Down 35 degrees as well as 20 degrees UP 1 at a rate of 15 degrees per second.
- This exquisitely designed N BOT is incredibly quiet and smooth in motion, so it won't interfere with in-studio shooting or your live Streaming.
- The NDI® hardware (silicon-based) achieves about 140Mbit at 1080p60 and is visually lossless.
- Power (POE+) and NDI stream through an Ethernet cable. The camera's zoom-in-out, focus and IRIS can be controlled remotely using the LANC input. N BOT simplifies video streaming with cableless.
- It stores and recalls up to 10 positions with a precision less than 0.1 degrees. Whether at the studio or on the stage, memorizes the previous location with extreme accuracy and immediately begins shooting.

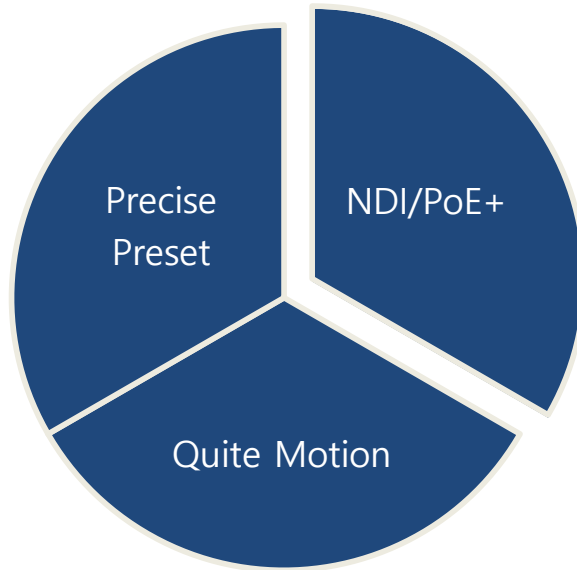

3. Technical Specification

	<ul style="list-style-type: none"> • Robotic Pan / Tilt Head
Input	<ul style="list-style-type: none"> • Supports Sony VISCA operation via Ethernet connection • POE+ (Power over Ethernet – 802.3at) support • HDMI video/audio input
Pan	Turning radius 170 degrees to the right and 170 degrees to the left (340 degrees) ** 360 degrees possible when the sensor is off** Speed: 180 degrees in 10 seconds (Variable speed in 1~24 steps)
Tilt	Turning radius up 20 degrees down 35 degrees Speed: 15 degrees per second (Variable speed from 1 to 24 steps)
Preset	10 position Save Save Pan/Tilt Position Save , Speed Save Zoom In/Out Position Save , Speed Save Pan/Tilt 1/3 (at Zoom Servo)
Ex-Control	<ol style="list-style-type: none"> 1. LANC input Camera Remotely control Zoom In/Out (Speed 1~12 step), Focus 2. Sony Multi Control (option) 3. Zoom Servo Control (option)
Tally	Internal / external Tally support
Output	NDI output to IP over Ethernet connection 1080p60 full HD resolution support Tally Light LANC , Sony Multi , Zoom Servo
Management	Front status LED support Support rear USB port service terminal Support for remote firmware update
Physis	Dimension : 128(H) X 157(W) X 157(D) Operation Temperature : 0~45°C Weight : 1.87 Kg Power Consumption: Max 30W

Input Voltage : AC220V 60Hz/ AC110V 60Hz/AC 24V 60Hz. **Power Consumption PAN:** 4.4W. **TILT:** 4.4WP/T Operating **Speed :** Left/ Right Rotation Speed: 5°/sec. **Up/Down Rotation. Speed:** 2°/sec **P/T Operation Angle Left/Right Rotation Angle:** 0°~340° **Up/Down Rotation Angle:** +45°~-85° **Operating Temperature :** -20°C~+50°C **Operating Humidity :** Less than 90%
Accurate Load: 5Kg **Color:** IVORY **Dimensions:** 152 (L)X147(H)X215(W) **Material:** ABS & ALUMINUM PLATE **Weight:** Approx. 2.2KG

Installation Precautions · It is recommended to install so that the height of the center of the housing at the top of the CAMERA MOUNT BASE is less than 50mm. Cause · Do not exceed the loading weight

(5kg) of this PAN-TILT and install it so that the center of the housing member coincides with the center of this PAN-TILT. How to operate TILT (upper, lower) angle In the figure above, if you loosen two bolts in the part where the label is drawn, you can see two bolts in the half-moon-shaped groove. Loosen these two bolts 2-3 turns to adjust to the desired angle position, and tighten so that it does not loosen, the angle adjustment is successful. How to operate the PAN (left, right) angle SPT-510 There are two bolts on the top of the connector at the bottom of the outside. Loosen these two bolts 2-3 turns to adjust them to the desired angle and tighten them so that they do not loosen.

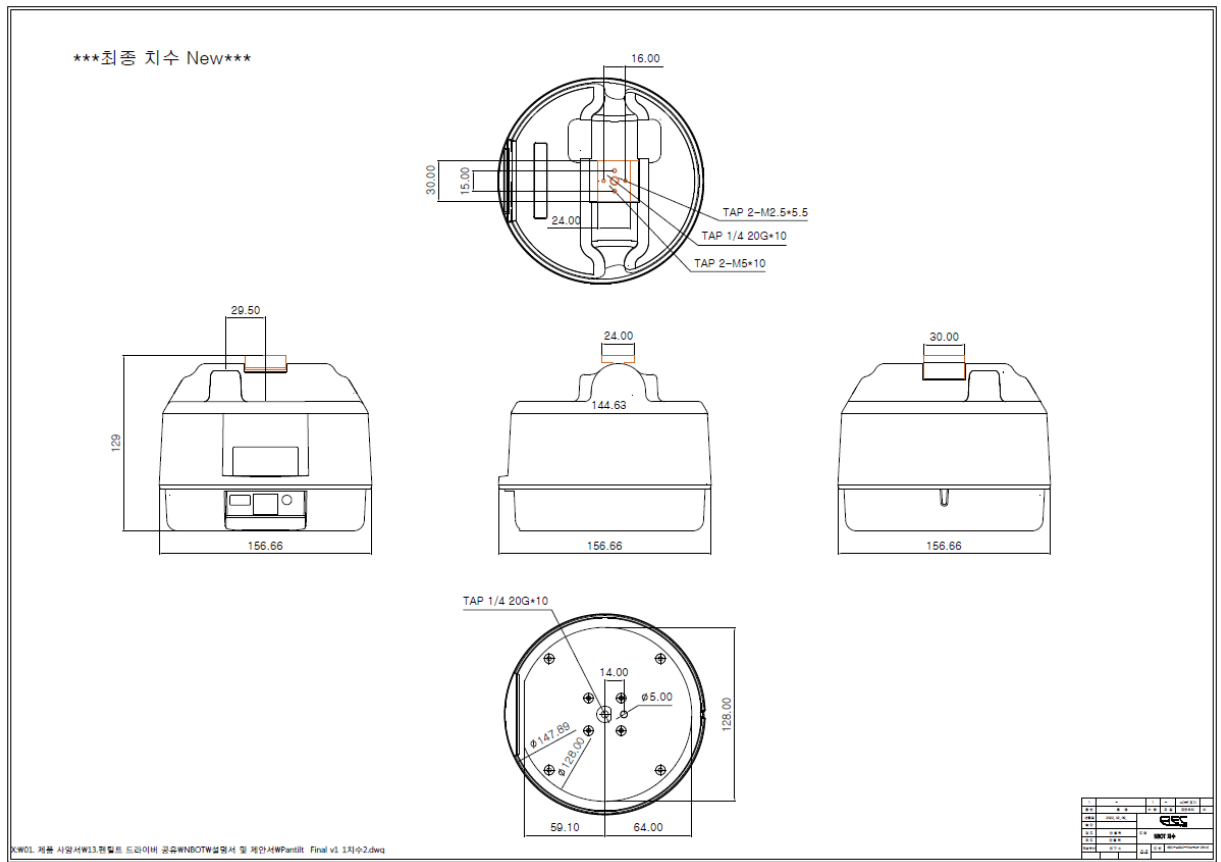

4. Product Overview

4.1. Part

4.1.1 Front

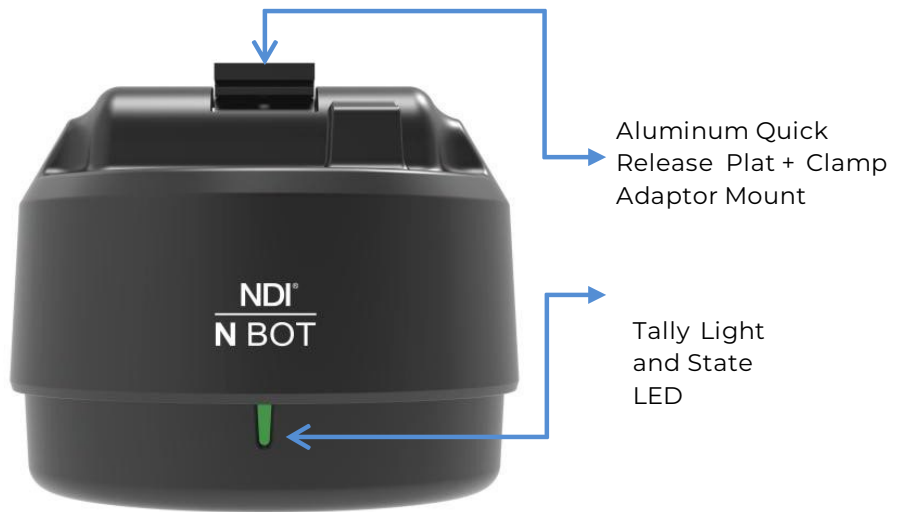

4.2. Rear

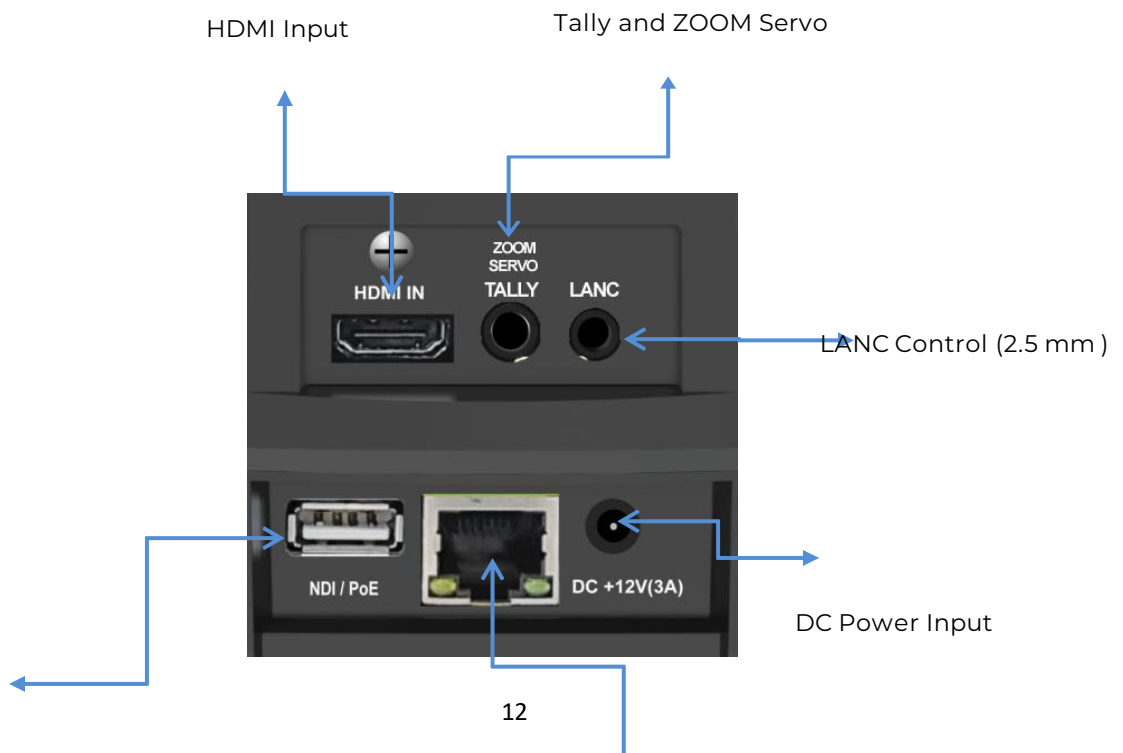

USB Connector

Ethernet (NDI/PoE+)

4.3 Components

This product consist of

1. N BOT PAN TILT Head
2. DC Power : DC 12V 3A
3. Quick Release Clamp Adaptor
4. LANC Cable (2.5π 3pol, 2.5π 3pol)
5. Multiport Converter Cable(OPTION) Multi Protocol (3.5π 4pol, Multiport)
6. Multiport LANC Cable(OPTION) LANC Protocol (2.5π 3pol, Multiport)



1. N BOT PAN TILT Head



2. DC power



3. Quick Release Clamp



4. LANC cable
(Option)



5. Multiport Converter Cable (Option)



6. Multiport LANC Cable

5. Operation

5.1. LED Status

The status LED has two colors, green and red, and the meaning of each color is as follows.



- Green blinking during booting
- Green blinks when command is received



- Red LED lights up when Tally On command
- Red LED turns off when Tally Off command

N BOT performs calibration by rotating 348 degrees at every boot.

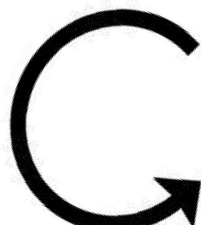

348°

5.2. System Diagram

As shown in the figure below, N BOT is easily connected to the legacy Internet network with a camera, IP switch, router and PC with a minimal cable Ethernet cable.

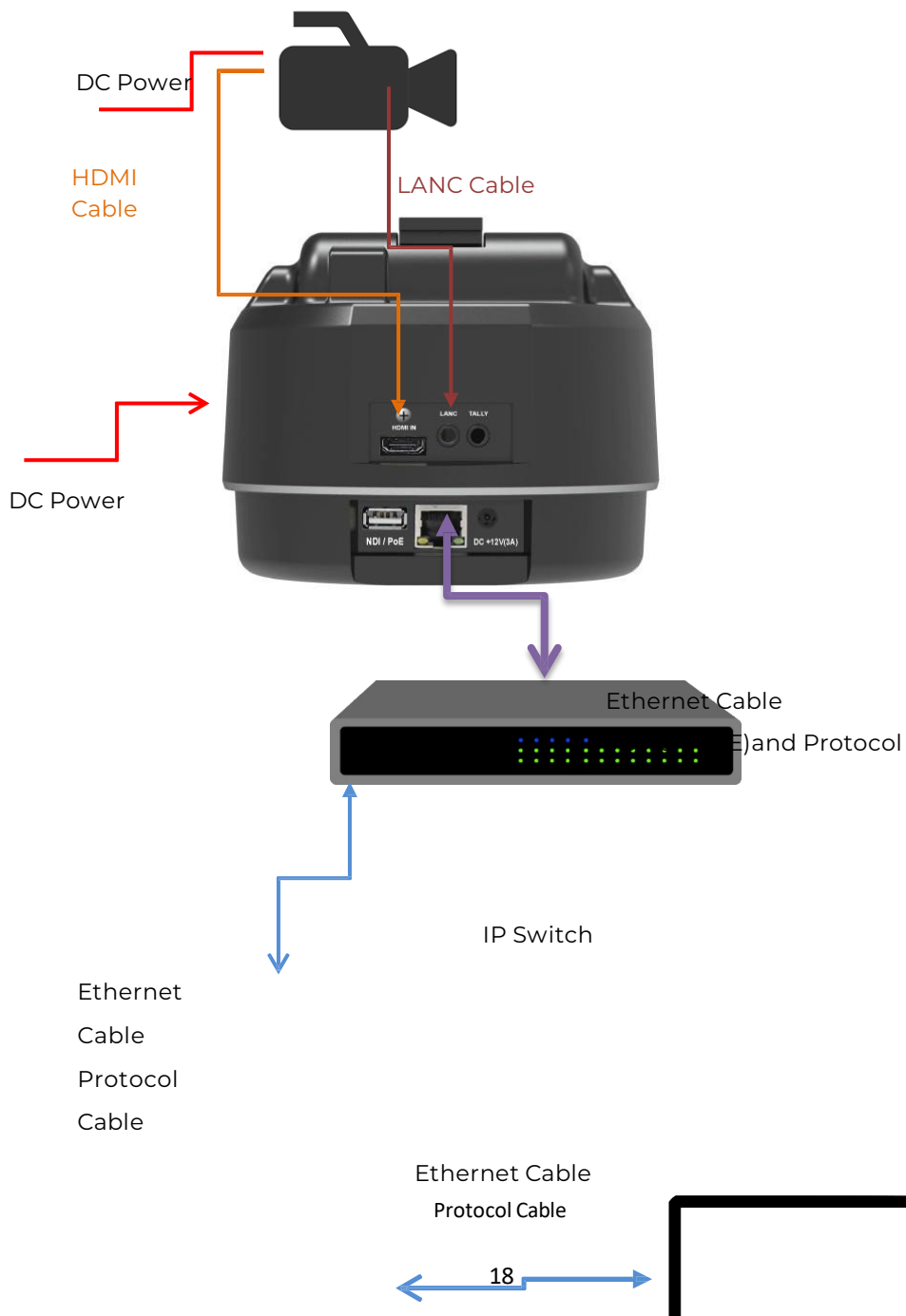



IP Router

5.3 N BOT Controlling

- It is possible to operate and intuitive preset with fine movements through VISC IP with SHARON proSTICK Controller
- Camera OSD, PAN TILT, Preset, can be controlled with Free SW(N BOT webserver) through NDI network.
- Free Studio monitors available on NDI, TV



SHARON proSTICK Controller

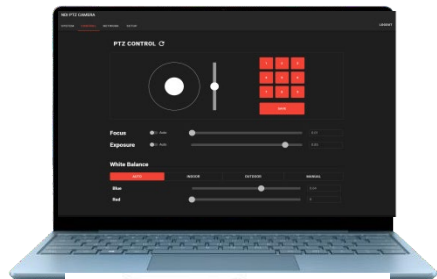

N

5.4 CAMERA COMPATIBILITY

- You should make sure that 2.5 mm LANC terminal is on the camera
- It must not exceed 3.2Kg including the lens
- To operate the ZOOM remotely, the motorized zoom (electric) must be installed on the camera.
- Auto or Manual is not converted thru LANC, but the Camera must be manually select in advance to able to remotely support Focus and Iris.



Black Magic Cinema



SONY



Panasonic



Canon



JVC

5.5 Video Over IP (NDI) Workflow

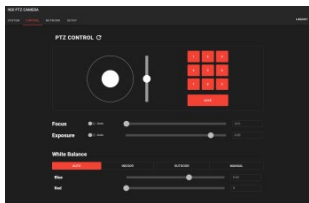

N BOT Webserver



NDI



Open Broadcaster Software



Wirecast



TRICASTER

SHARON proSTICK



6. SHARON Finder

6-1. SHARON Finder Apps Download

Please visit to SalrayWorks download page as below and you can download and install Sharon finder app for both of Window and MAC OS version.

<http://salrayworks.com/index.php/download/ndi-finder-for-window-pc/>

SHARON FINDER for Window OS

POSTED 2021년 MARCH 4일 ANYHELP SALRAYWORKS

SW UTILITY	
Version	1.01
Download	89
File Size	61.97 MB
File Count	1
Create Date	2021년 March 4일
Last Updated	2021년 December 2일

SHARON FINDER for Window OS

SHARON: Discovery Utility for Window PC

- Search SHARON 360, 30, 20 PTZ camera IP Address
- Reset PW

SHARON FINDER for MAC

POSTED 2021년 MARCH 4일 ANYHELP SALRAYWORKS

SW UTILITY	
Version	1.01
Download	48
File Size	73.91 MB
File Count	1
Create Date	2021년 March 4일
Last Updated	2021년 December 2일

SHARON FINDER for MAC

NDI Discovery Utility for MAC









When the installation is complete, the Desktop SHARON Finder Icon will appear on your Desktop



6-2. SHARON Finder GUI

If you click SHARON finder icon, the following window appears, scan all NDI devices on the same Network and display a list as below.

NDI Finder

Devices			
HOST	IP	MAC	ACTION
TEST	192.168.0.18 ✓	00:1e:c0:8f:7a:46	  
SHAROM360-111	192.168.0.111 ✓	04:91:62:d4:e7:1e	  
nBOT	192.168.0.100 ✓	68:27:19:8a:7c:86	  

Rows per page: 10 1-3 of 3



6-3. Re-Name and Re-Configure IP Address

It is possible to change the IP address or Change the name of N BOT as below Menu.

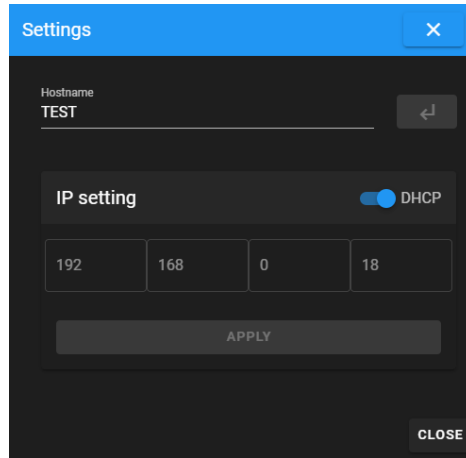

6-4. Reboot N BOT

You can reboot the connected N BOT.

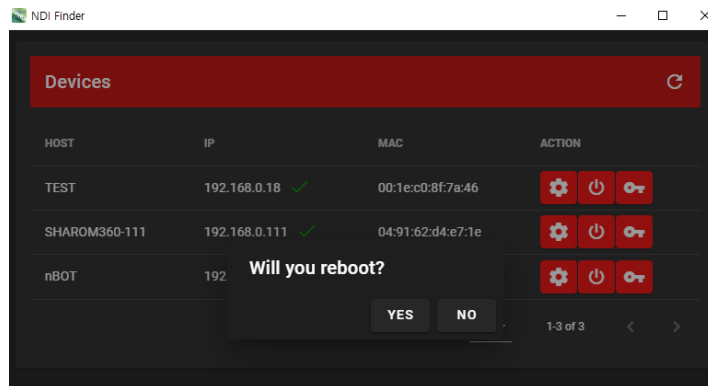

6-5. Reset Password

If forgot PW, and reset PW

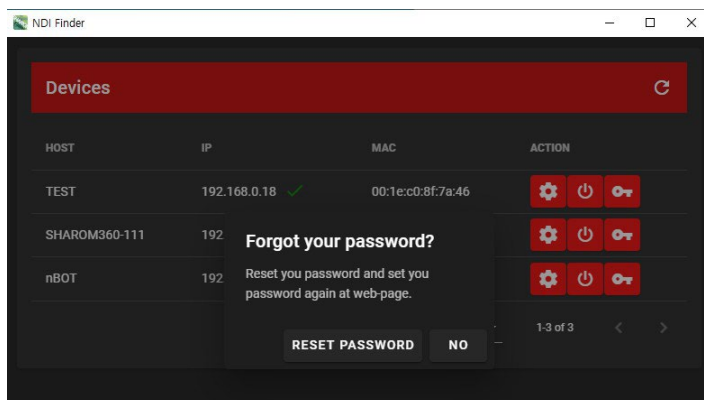

7. N BOT Webservice

7-1. Log In

Open a Web-Browser and enter address 192.168.0.100 to open the login Window as below or if the password is not correct, please find update IP address by SHARON Finder.

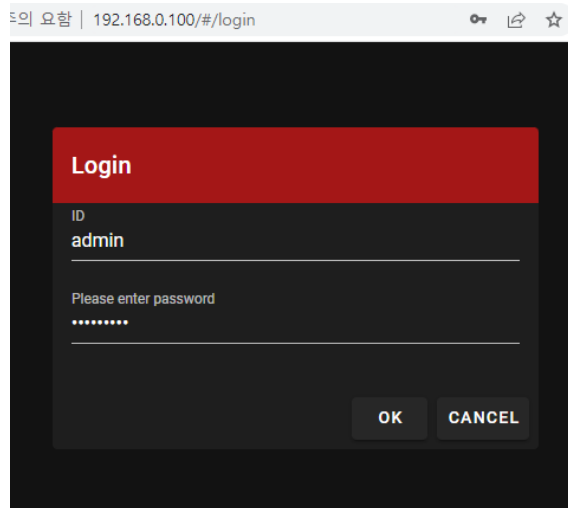

7-2. System Mode

You can find the firmware version and current IP address in the system Menu, and check the current real-time CPU usages in CPU menu and check the current video resolution in Video and the Bit rate in Audio Menu. And real time monitoring of current Bandwidth usage in Network

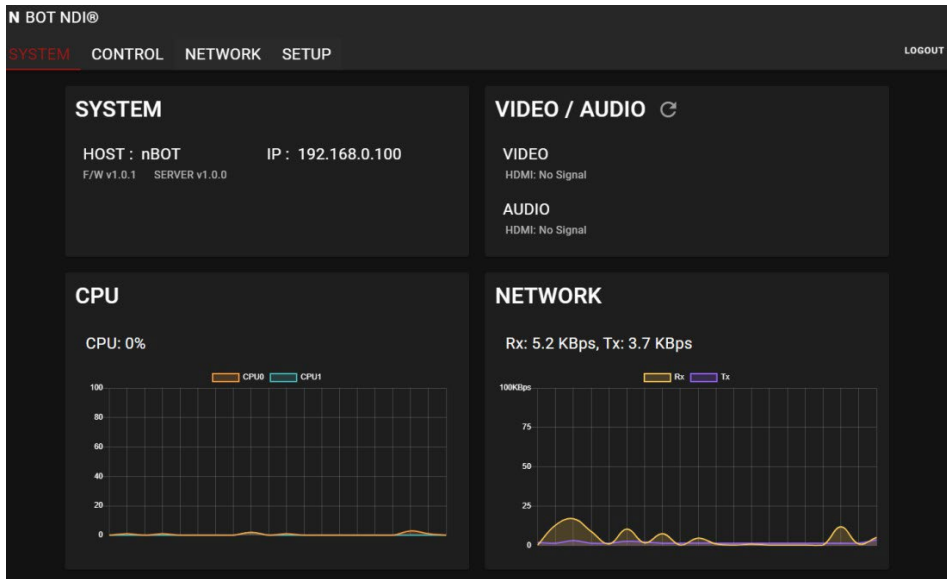

7-3. Control Mode

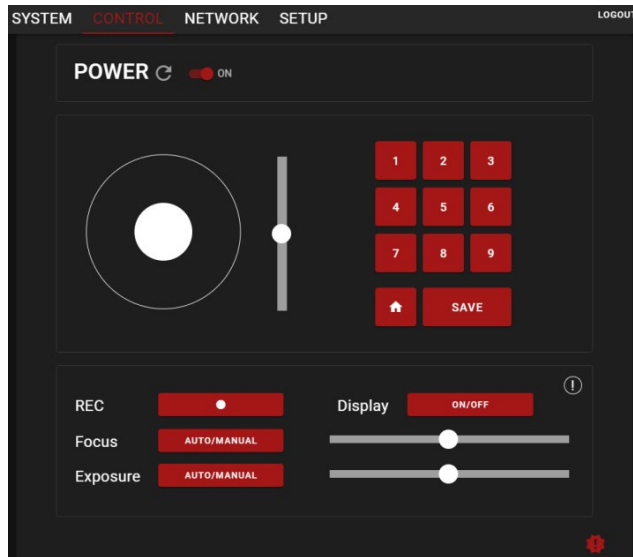

Power, REC, Display, Auto-Focus : These functions can be operated remotely via LANC.

However, the connected Camera Model must support the LANC protocol for these functions. If the camera model does not support thru LANC, you must manually set the focus in advance. Only then can the focus be adjusted remotely above menu.

If the toggle button above does not work , connected camera is not supported. Up to **9 presets** can be saved and recalled.



If the camera falls into a locked state due to an external shock or the weight of camera, click the icon above to display Forced Driving menu as shown below, allowing you to forcibly move the camera's PAN TILT.

Forced Driving

! If a dead lock occurs outside the limited range, forced operation is possible.



CLOSE

7-4. Network Mode

In the Network Menu, you can change the name or IP address of currently contacted N BOT. You can select the transmission specified in the current SDI SDK version., and you can decide whether to apply the NDI group Setting.

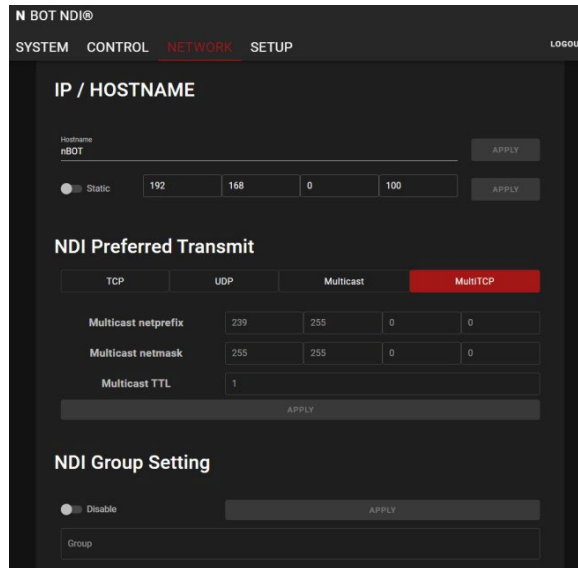

7-5. Smart Phone Mode

If you turn on WIFI on your smartphone, open a Chrome on the same network and enter the address of 192.168.0.100 you can operate the N BOT web server as below (Automatically fit the screen size)

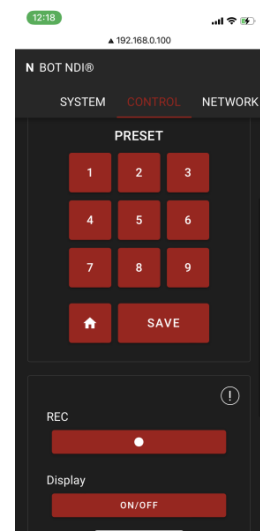
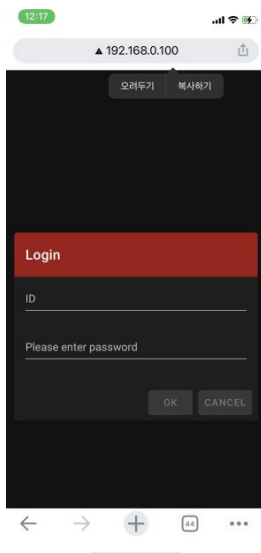

Log In Mode

Control Mode

Control Mode

8. SONY Multiport Converter Module.



8-1 The List of Camera Model

Some Sony camera models can be remotely controlled only through the Multi interface Shoe instead of the 2.5 mm LANC terminal. In this case, you must purchase the SONY Multiport Converter Module separately.

Remote support for the following function.

- Zoom Tele (SW command)
- Zoom Wide (SW command)
- Recoding Start/Stop(SW command)
- Auto Focus (SW command & HW command)

- Power On/Off (HW command)
- Sutter (SW command & HW command)

8-2What to check if it doesn't work

- The installed ZOOM lens must have a power zoom lens type.
- Firmware version installed in N BOT must be 2.1.0 or higher

- In Zoom, the setting must be set to SERVO
- The cable must be installed before powering on the NBOT so that it can recognize the cable when booting.

8-3 List of SONY Camera supported by SONY MULTIPOINT Interface shoe

A1	A7RM4A	A7RM3A	A7 IV
A6500	A6400	A6300	A6000
A5100	A5000	A3500	A3000
A7 III	A7 II	A7	A7R III
A7R II	A7R	A7S II	A7S
A9	ILCE-QX1	A7R IV	A6100
A6600	A9 II	A7S III	
A99 II	A77 II	A68	A58
RX100 VII	ZV-1	RX0M2	
RX100 VI	RX100 VA	RX100 V	RX100 IV
RX100 III	RX100 II	RX10 IV	RX10 III
RX10 II	RX10	RX1R II	WX800
WX700	WX500	HX300	HX350
HX400	HX400V	HX50	HX50V
HX60	HX60V	HX80	HX90V
HX95	HX99	QX30	RX0 *
FDR-AX43			
FDR-AX100	FDR-AX100E	FDR-AX30	FDR-AX33
FDR-AX40	FDR-AX45	FDR-AX53	FDR-AX55
FDR-AX60	FDR-AX700	FDR-AXP33	FDR-AXP35
FDR-AXP55	HDR-CX220	HDR-CX220E	HDR-CX230
HDR-CX230E	HDR-CX240	HDR-CX240E	HDR-CX280
HDR-CX280E	HDR-CX290	HDR-CX290E	HDR-CX320
HDR-CX320E	HDR-CX330	HDR-CX330E	HDR-CX380
HDR-CX380E	HDR-CX390	HDR-CX390E	HDR-CX400E
HDR-CX405	HDR-CX410VE	HDR-CX420	HDR-CX430V
HDR-CX430VE	HDR-CX440	HDR-CX450	HDR-CX455
HDR-CX470	HDR-CX480	HDR-CX485	HDR-CX510E
HDR-CX530E	HDR-CX535	HDR-CX610E	HDR-CX620
HDR-CX625	HDR-CX630V	HDR-CX670	HDR-CX675
HDR-CX680	HDR-CX900	HDR-CX900E	HDR-PJ220
HDR-PJ220E	HDR-PJ230	HDR-PJ230E	HDR-PJ240
HDR-PJ240E	HDR-PJ270	HDR-PJ270E	HDR-PJ275
HDR-PJ320E	HDR-PJ330E	HDR-PJ340	HDR-PJ340E
HDR-PJ350	HDR-PJ350E	HDR-PJ380	HDR-PJ380E
HDR-PJ390	HDR-PJ390E	HDR-PJ410	HDR-PJ420E
HDR-PJ420VE	HDR-PJ430	HDR-PJ430E	HDR-PJ430V
HDR-PJ430VE	HDR-PJ440	HDR-PJ510E	HDR-PJ530E
HDR-PJ540	HDR-PJ540E	HDR-PJ610E	HDR-PJ620
HDR-PJ630V	HDR-PJ650E	HDR-PJ650V	HDR-PJ650VE
HDR-PJ660	HDR-PJ660E	HDR-PJ660V	HDR-PJ660VE
HDR-PJ670	HDR-PJ675	HDR-PJ680	HDR-PJ780E
HDR-PJ780VE	HDR-PJ790	HDR-PJ790E	HDR-PJ790V
HDR-PJ790VE	HDR-PJ800	HDR-PJ810	HDR-PJ810E
HDR-PJ820	HDR-PJ820E		

8-4 List of camera tested in the ZFC-L zoom and focus control

November 2019

	Model	Terminal	HDMI	Rec	Zoom	Focus
Sony	HVR-V1	LANC	○	○	○	○
	HVR-Z5	LANC	○	○	○	○
	HVR-Z7	LANC	○	○	○	N/A
	HVR-HD1000	LANC	○	○	○	○
Panasonic	BH1	LANC	○	○	○	○

N BOT VISCA IP Commands

Execution and Inquiry Command List

Command Set	Command	Command Packet	Comments
Inquiry Command	Command Packet	Inquiry Packet	Comments
CAM_VersionInq	8x 09 00 02 FF	y0 50 00 01 mn pq rs tu vw FF	mnpq: Model Code (0x11 0x20) rstu: ROM version (0x00 0x01) vw: Socket Number (0x01)
CAM_Power	On	8x 01 04 00 02 FF	Power ON/OFF
	Off (Standby)	8x 01 04 00 03 FF	
CAM_PowerInq	8x 09 04 00 FF	y0 50 02 FF	On
		y0 50 03 FF	Off (Standby) - at Visca Only On
CAM_Ext_ZoomServo	Reset	8x 11 06 05 FF	Zoom Servo Reset
	Direction Reverse	8x 11 04 07 4p FF	p: 0 (forward) to 1 (reverse)
	AbsolutePosition	8x 11 04 47 2p 0p 0q 0r 0s FF	p: 1 (Slow) to 7 (Fast) pqr: Zoom Position (MIN 0x0000, MAX 0x4000)
	RelativePosition	8x 11 04 47 3p 0p 0q 0r 0s FF	p: 1 (Slow) to 7 (Fast) pqr: Zoom Position (MIN -0x4000, MAX 0x4000)
CAM_Ext_ZoomServo_PosInq	8x 09 04 47 FF	y0 50 0p 0q 0r 0s FF	pqr: Zoom Position (MIN 0x0000, MAX 0x4000)
CAM_Block_BEClng	8x 29 04 50 FF	y0 50 0w 0w 0w 0w 0t 0t 0t 0e Or 0v 00 00 00 00 00 00 00 00 FF	www: zoom servo Limit Width tttt: zoom servo Limit Torque e: zoom servo Exist r: zoom servo direction Reverse v: zoom servo Version
CAM_Zoom	Stop	8x 01 04 07 00 FF	Zoom Control
	Tele (Standard)	8x 01 04 07 02 FF	
	Wide (Standard)	8x 01 04 07 03 FF	
	Tele (Variable)	8x 01 04 07 2p FF	
	Wide (Variable)	8x 01 04 07 3p FF	
CAM_Focus	Stop	8x 01 04 08 00 FF	p=1 (Low) to 7 (High)
	Far (Standard)	8x 01 04 08 02 FF	
	Near (Standard)	8x 01 04 08 03 FF	
	Far (Variable)	8x 01 04 08 2p FF	
	Near (Variable)	8x 01 04 08 3p FF	
	Auto Focus	8x 01 04 38 02 FF	
	Manual Focus	8x 01 04 38 03 FF	
Auto/Manual	8x 01 04 38 10 FF	AF ON/OFF Toggle	
CAM_Iris	AUTO	8x 01 04 39 00 FF	Iris Setting Up(-1), Down(+1)
	MANUAL	8x 01 04 39 03 FF	
	Up (OPEN)	8x 01 04 0B 02 FF	
	Down (CLOSE)	8x 01 04 0B 03 FF	
CAM_Preset	Reset	8x 01 04 3F 00 0p FF	p : preset 0 ~ 9
	Set	8x 01 04 3F 01 0p FF	
	Recall	8x 01 04 3F 02 0p FF	

Execution and Inquiry Command List

Command Set	Command	Command Packet	Comments
Inquiry Command	Command Packet	Inquiry Packet	Comments
CAM Info Display	On/Off	8x 01 06 06 10 FF	Turn On/Off Info screen
VideoSystemSETInq	8x 09 06 23 FF	y0 50 pp FF	00 : 1920x1080p60 01 : 1920x1080i60 02 : 1920x1080p30 03 : 1280x720p60 04 : 1280x720p30 05 : 1920x1080p59 06 : 1920x1080i59 07 : 1280x720p59 08 : 1920x1080p50 09 : 1920x1080i50 0A : 1920x1080p25 0B : 1280x720p50 0D : 1920x1080p29 23 : 1920x1080p23 24 : 1920x1080p24 35 : DETECT_ERROR 36 : UNKNOWN
Pan_tiltDrive	Up	8x 01 06 01 VV WW 03 01 FF	VV: Pan speed 0x01 to 0x18 (00: Stop) WW: Tilt Speed 0x01 to 0x17, (00: Stop) YYYY: Pan Position ZZZZ: Tilt Position (center 0000) Refer to the section of the Pan/ Tilt Position (for reference) of VISCA Command Setting Values.
	Down	8x 01 06 01 VV WW 03 02 FF	
	Left	8x 01 06 01 VV WW 01 03 FF	
	Right	8x 01 06 01 VV WW 02 03 FF	
	UpLeft	8x 01 06 01 VV WW 01 01 FF	
	UpRight	8x 01 06 01 VV WW 02 01 FF	
	DownLeft	8x 01 06 01 VV WW 01 02 FF	
	DownRight	8x 01 06 01 VV WW 02 02 FF	
	Stop	8x 01 06 01 VV WW 03 03 FF	
	AbsolutePosition	8x 01 06 02 VV WW 0Y 0Y 0Y 0Y 0Z 0Z 0Z 0Z FF	
RelativePosition	8x 01 06 03 VV WW 0Y 0Y 0Y 0Y 0Z 0Z 0Z 0Z FF		
Home	8x 01 06 04 FF		
Pan_tiltPosInq	8x 09 06 12 FF	y0 50 0w 0w 0w 0w 0z 0z 0z 0z FF	wwww = Pan Position zzzz = Tilt Position

Execution and Inquiry Command List

Command Set	Command	Command Packet	Comments
Inquiry Command	Command Packet	Inquiry Packet	Comments
CAM_TallyLamp	On/Off	8x 01 7E 01 0A 00 0p FF	p: 2h=On, 3h=Offf
CAM_TallyLampInq	8x 09 7E 01 0A FF	y0 50 02 FF	On
		y0 50 03 FF	Off
CAM_AudioStateInq	8x 09 06 24 FF	y0 50 pp FF	00h : UNKNOWN: 02h : 32KHZ 04h : 44KHZ 06h : 48KHZ 08h : 88KHZ 10h : 96KHZ 12h : 176KHZ 14h : 192KHZ

Pan/Tilt Position (for reference) for VISCA Command Setting Values Pan

Command Set	Command	Command Packet	Comments
Inquiry Command	Command Packet	Inquiry Packet	Comments
CAM_TallyLamp	On/Off	8x 01 7E 01 0A 00 0p FF	p: 2h=On, 3h=Offf
CAM_TallyLampInq	8x 09 7E 01 0A FF	y0 50 02 FF	On
		y0 50 03 FF	Off
CAM_AudioStateInq	8x 09 06 24 FF	y0 50 pp FF	00h : UNKNOWN: 02h : 32KHZ 04h : 44KHZ 06h : 48KHZ 08h : 88KHZ 10h : 96KHZ 12h : 176KHZ 14h : 192KHZ

Tilt

Angle (degrees)	Up	Down
	ZZZZ values	ZZZZ values
0	0000	0000
5	00A6	FF5A
10	014D	FEB3
15	01F3	FE0D
20	029A	FD66
25	-	FCBF
30	-	FC19
35	-	FB72
40	-	FACB